

EBDHS-MB

Luminaire mount high bay PIR detectors

Overview



The EBDHS-MB PIR (passive infrared) presence detector provides automatic control of lighting loads with optional manual control. The EBDHS-MB is a high sensitivity PIR detector suitable for high bay applications, such as warehouses and factories, and where high detection sensitivity is needed. It is specifically designed for mounting onto a batten style luminaire.

Three models are available: premium, direct dim, and analogue dim all of which will switch incandescent, fluorescent, compact fluorescent and LED lighting. The direct dim variant controls DALI or DSI digital dimming ballasts whilst the analogue dim variant controls 1-10V dimming ballasts.

The unit detects movement using a PIR sensor and turns the load on. When an area is no longer occupied the load will switch off after an adjustable time out period.

The units are IP65 rated as standard and are therefore suitable for outdoor use as well as wet and wash-down areas.

A selection of fixing washers are supplied to aid fixing to a variety of luminaires.

All functionality is fully programmable using an IR handset.

Features

Front view



PIR Sensor

Detects movement within the unit's detection range, allowing load control in response to changes in occupancy.

IR Receiver



Receives control and programming commands from an IR (infrared) handset.

Light Level Sensor

Measures the overall light level in the detection area

Status LED

The LED flashes Red to indicate the following:

Walk Test LED active	 when movement is detected
Valid setting received	



EBDHS-MB-AD-LT30 EBDHS-MB-DD-LT30 & EBDHS-MB-PRM-LT30

Special order versions that can be used down to -30°C

Detection diagrams

Range

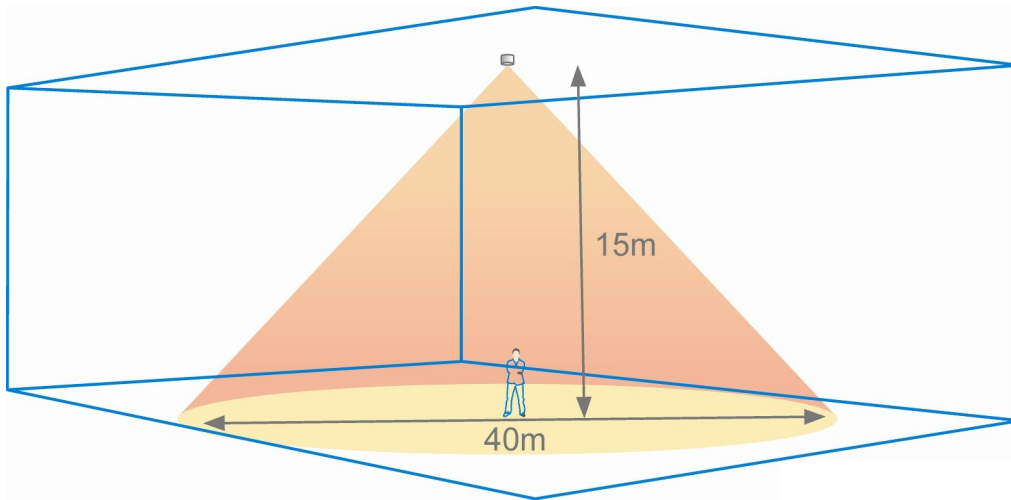

Maximum mounting height 20m

Detection pattern

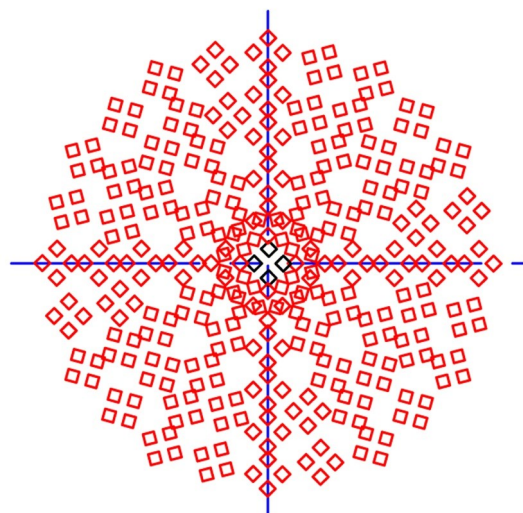
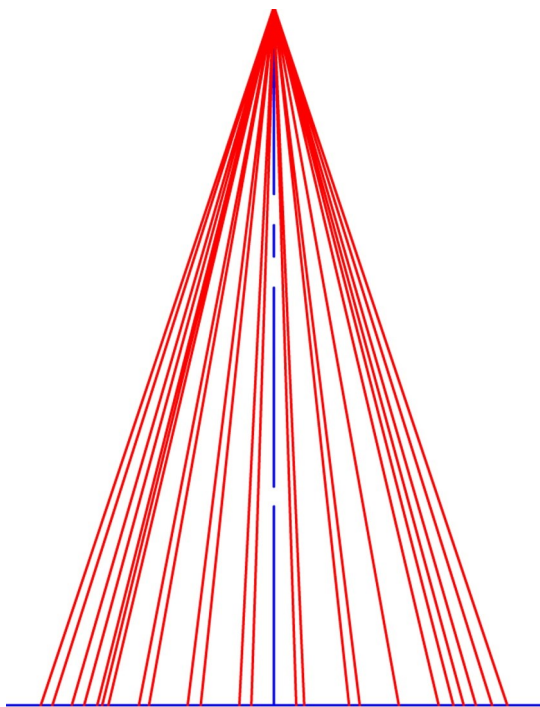

Walk across

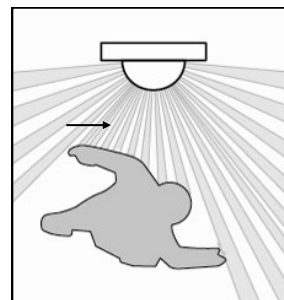

Height	Range Diameter
15m	40m
10m	26m
6m	16m
3m	9m

Walk towards

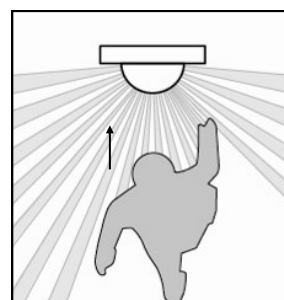

Height	Range Diameter
15m	30m
10m	20m
6m	12m
3m	8m

Alignment marks

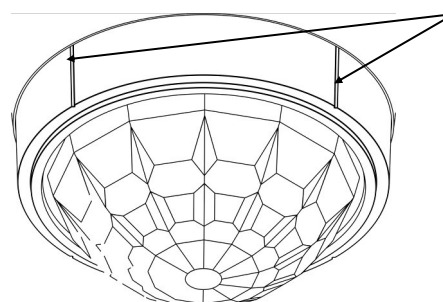

The sensor head has 4 alignment marks. These correspond to the 4 outer passive infrared sensors under the lens. Use these marks to align with aisles and corridors to ensure the best detection characteristics. See example overleaf.

Masking

The EBDHS-MB includes two clip-on masking shields to allow for precise masking of the detection shape. The masks can be easily shaped to produce detection patterns suitable for applications such as aisles and corners and for narrowing the detection diameter.

Important note. Ensure all infra-red (IR) programming is completed before affixing the masking shields to the detector.

The masking shields may impair the light sensor and IR sensors by covering them. Ensure correct operation before completing commissioning.

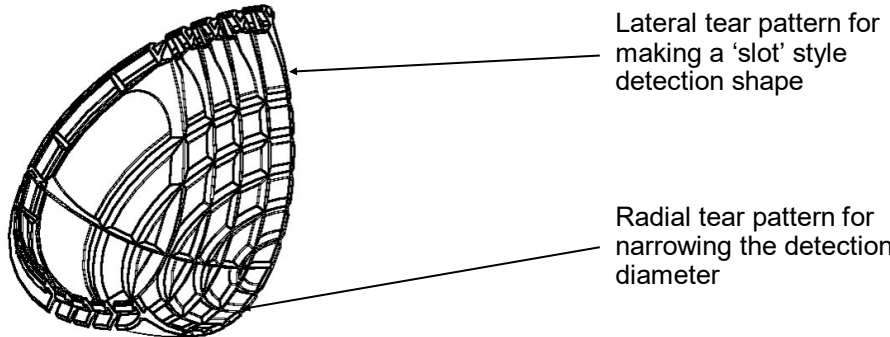

Aisles

Masking shields trimmed for aisle shaped detection

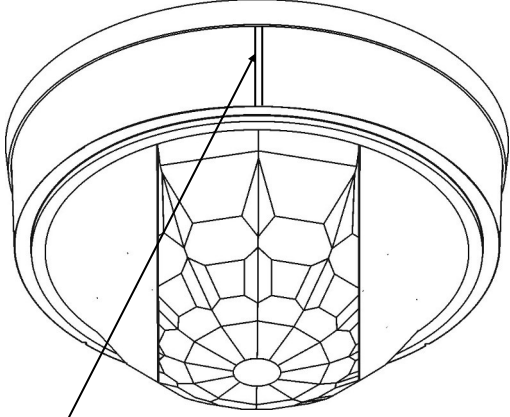

Align trimmed shields with sensor head alignment marks and aisle.

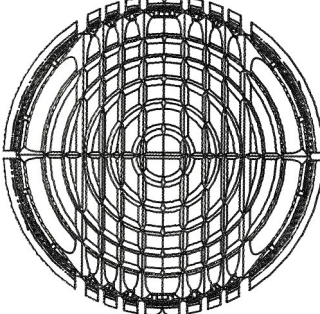

Slot number 1 2 3 4 4 3 2 1

Slot number	Masking shield % coverage
1	45%
2	32%
3	22%
4	11%

Example
 Mounting height 6m
 Trimmed to slots 2
 Aisle detection width 16m x 32% = 5.1m walk across
 12m x 32% = 3.8m walk towards

Narrow detection

Masking shields trimmed for a narrow beam of detection

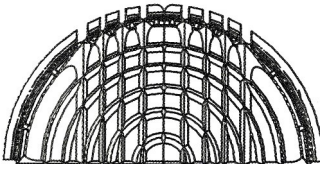
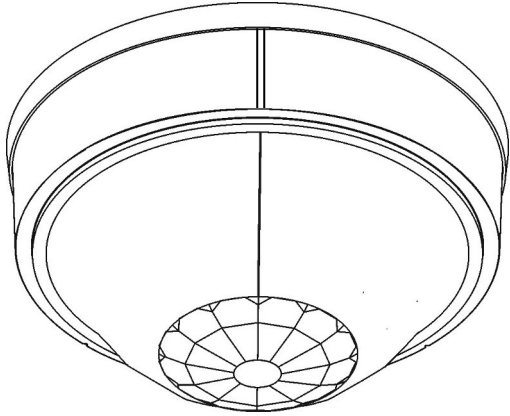

Diameter number 1 2 3 4 5 5 4 3 2 1

Diameter number	Masking shield % coverage
1	89%
2	63%
3	45%
4	32%
5	22%

Example
 Mounting height 15m
 Trimmed to diameter 3
 Detection diameter 40m x 45% = 18m walk across
 30m x 45% = 13.5m walk towards

Installation

The product is designed to be mounted directly to the outside of a luminaire. The detector should be sited so that the occupants of the room fall inside the detection pattern (shown opposite), at a recommended ceiling height of 2.8m. Note that the lower the sensor is installed the smaller the detection range will be, subject to the parameters shown on the detection diagram.

- For optimum operation of the lux sensor, the lens must be shielded as much as possible from the light source.
- Avoid direct sunlight entering the sensor.
- Do not site within 1m of forced air heating or ventilation.
- Do not fix to a vibrating surface.

Sensor functionality

Detection mode

- **Presence** When movement is detected the load will automatically turn on. When the area is no longer occupied the load will automatically switch off after an adjustable time period.

Sensitivity to movement of the PIR sensor can be adjusted using the Sensitivity parameter.

HINT: To assist in setting the Sensitivity, turn on the Walk Test LED which will flash red when movement is detected.

Switch Level On/Off

Occupancy detection can be made dependant on the ambient light level using the Lux On Level and Lux Off Level parameters.

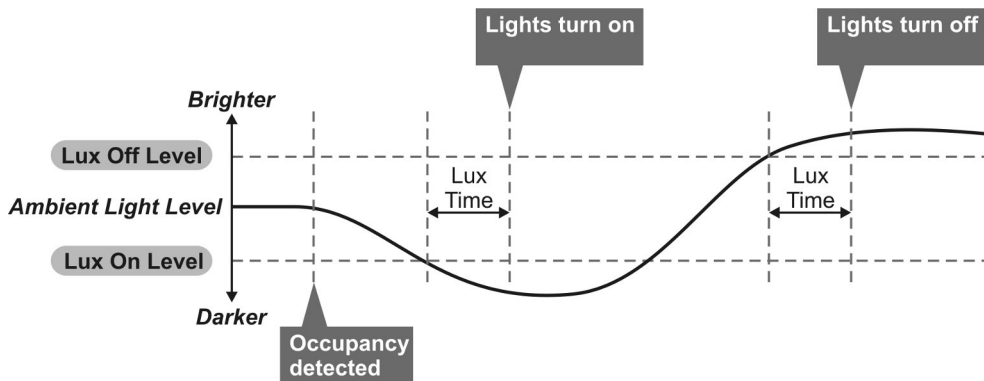

Maintained Illuminance (daylight harvesting) - DD and AD variants only

The detector measures the overall light level in the detection area and calculates the correct output for the luminaires, to achieve a preset lux level (maintained illuminance or daylight harvesting).

Burn-in - DD and AD variants only

Burn-in - DD and AD variants only

• Overview



It is a requirement of many fluorescent lamp manufacturers to have the lamps on at maximum output for a period of time to guarantee lamp life (refer to the manufacturer's datasheet for details). As the EBDHS-MB-DD & AD are able to dim the lamps using DALI/DSI or 1-10V, the products provide a facility to disable this for a given period of time.

• Operation

By setting the "Burn in" parameter, you can select a time during which the lamps are not allowed to deviate from maximum output. The unit counts the time, and even remembers how long has elapsed in the event of a power failure. To cancel the burn in function, simply select a time of 0. Note that when the lamps are changed, the burn in time should be set again.

Do not grip unit at the lens end. Hold the square body near the threaded end when installing and tightening the nut. Care must be taken to prevent damage to the lens and surrounding IP seal.

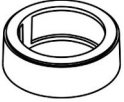
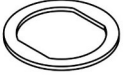
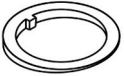
Components

Part	Quantity Supplied
 IP Spacer with silicone coating	1
 Silicone washer	1
 5° washer	1
 5° spacer	1
 M20 nut	1

Mounting hole without key

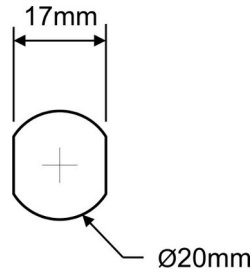

Mounting hole with key

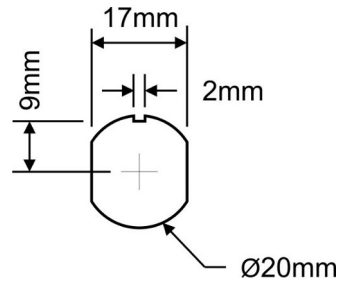

Note. Key to be at top of sensor.

Standard luminaire fitting

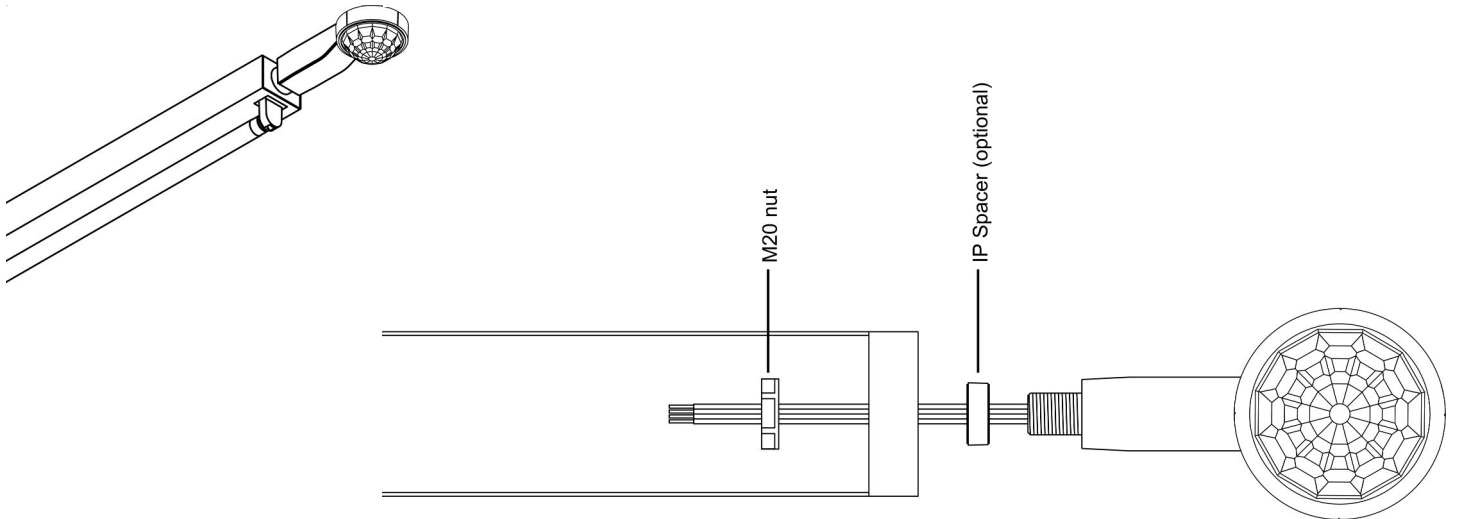

IP luminaire fitting

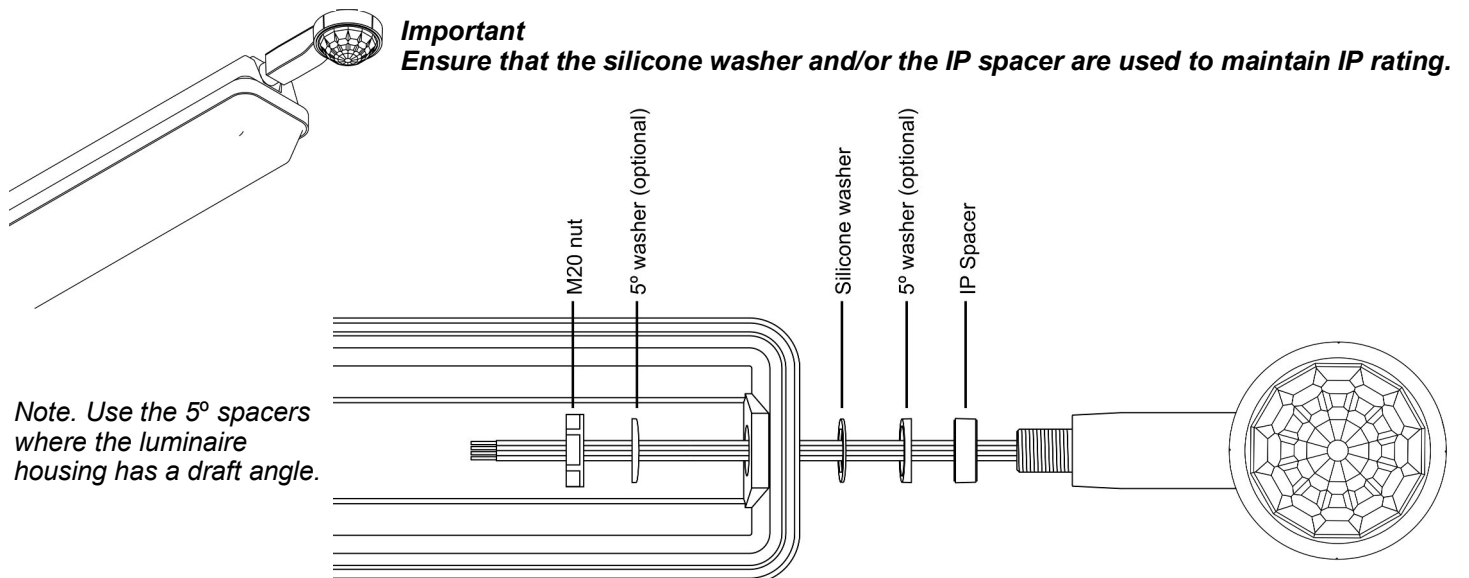

Wiring diagrams

Wire the products as shown in the diagrams.

EBDHS-MB-PRM

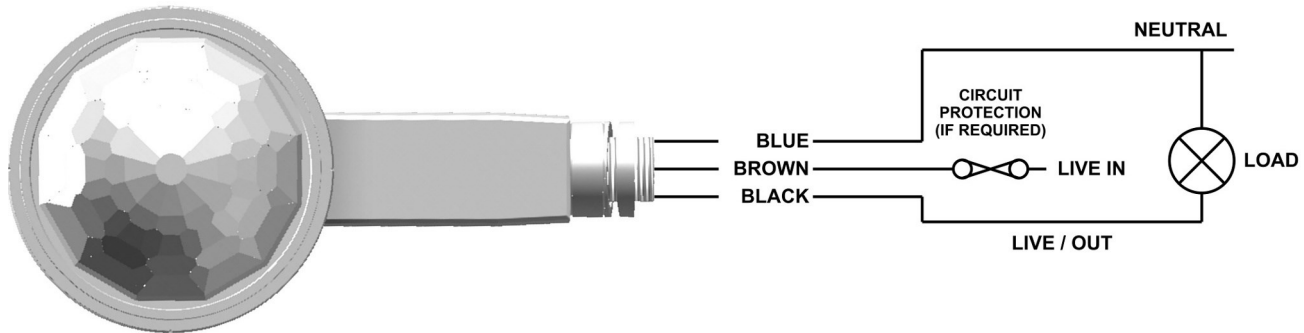

EBDHS-MB-DD

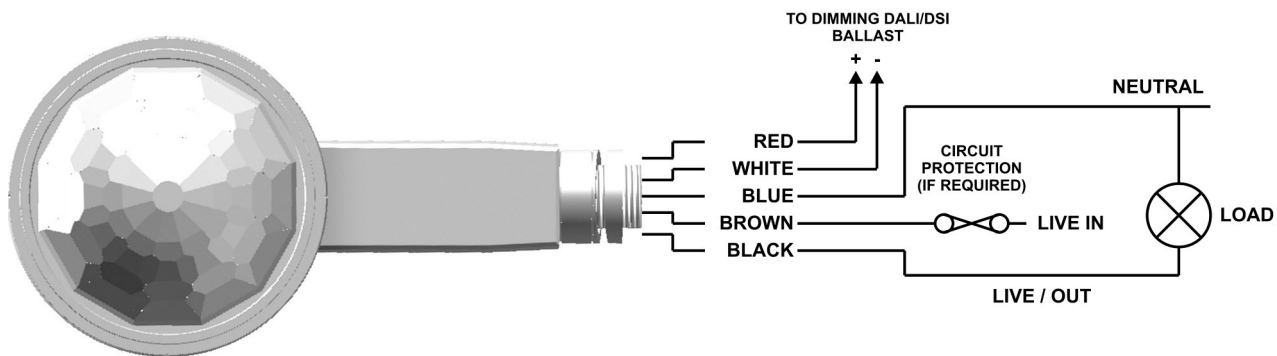

EBDHS-MB-AD

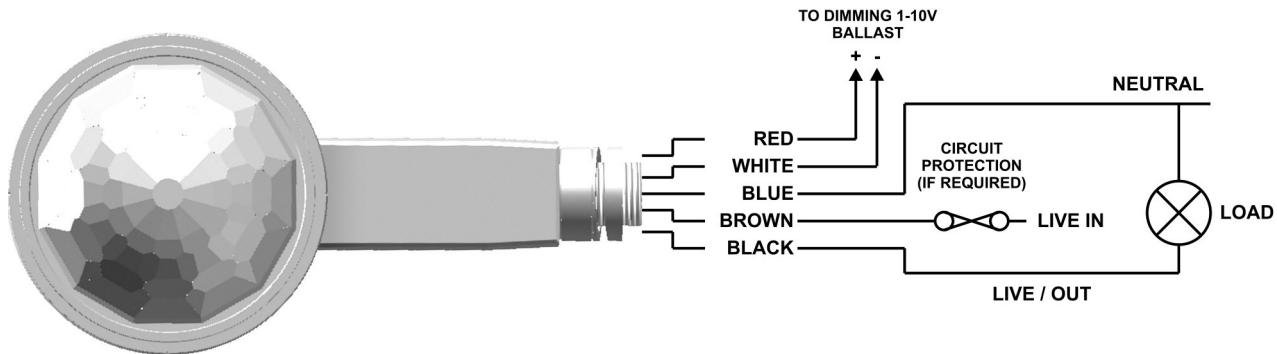

Power-up test procedure

- When power is applied to the unit, the load will turn on immediately.
- Set the timeout to 10 seconds, vacate the room or remain very still and wait for the load to switch off .
- Check that the load switches on when movement is detected.
- The unit is now ready for programming.

Fault finding

What if the load does not turn ON?

- Check that the live supply to the circuit is good.
- Check that the load is functioning by bypassing the sensor (e.g. link **L** and **L/ Out**).

HINT: *The Walk Test LED function can be used to check that the unit is detecting movement in the required area.*

What if the load does not turn OFF?

- Ensure that the area is left unoccupied for longer than the Time Out Period.
- Ensure that the sensor is not adjacent to circulating air, heaters or lamps.
- If the unit "false triggers" reduce the sensitivity using the sensitivity settings

Readback function *(only with UNLCDHS handset)*

The UNLCDHS has the ability to read back the settings stored in a device.

To read back individual parameters

- Navigate to the parameter and press the 'R' (Read) button whilst pointing at the device. The handset will click when the parameter has been read back, the device will flash its LED, and the value will be shown against the parameter in the menu.

To read back all of the parameters in a menu

- Press and hold the 'R' (Read) button for more than 1 second.
- The handset will click every time a parameter is received
- The device will show multiple flashes of its LED
- All of the values will be shown against the parameters in the menu.
- The individual parameters may be edited and then saved as a 'Macro'.

Notes

- *If a parameter(s) has been missed because of a communication error, the missing value(s) is replaced by dashes.*
- *When reading back, the Channel 1 relay (where fitted) will temporarily be switched off, and will return to it's normal state 2 seconds after the read back has been completed.*

Basic programming - PRM, DD and AD variants



The functionality of the EBDHS-MB-PRM, DD & AD are controlled by a number of parameters which can be changed or programmed by any of the following devices:

- **UHS5** Infrared Handset. See below for programmable functions.
- **UNLCDHS** Infrared Handset (with LCD). See user guide for full programming details.

For most basic programming operations the UHS5 handset can be used and the following procedures are based on using this device.

Point the handset at the Sensor and send the required programming commands to the unit as shown below.

Valid commands will be indicated by a red LED flash. See page 1 for details of other LED responses.

Note: other functions on the UHS5 which are not shown below are not applicable to this product.

Parameter Name	Default Value	Number of Shift key presses				UHS5 Handset Graphics	Description
		0 SHIFT 1 SHIFT 2	1 SHIFT 1 SHIFT 2	2 SHIFT 1 SHIFT 2	3 SHIFT 1 SHIFT 2		
Button Activation							
On / Raise		On	Raise				Turn lights on or to raise lights.
Off / Lower		Off	Lower				Turn lights off or to lower lights.
Walk test	Off	On	Off				When set to On this causes a red LED to flash on the sensor when it detects movement. Use this feature to check for adequate sensitivity levels.
Time Out (Time adjustment)	20 mins	1, 10 & 20 minutes	5, 15 & 30 minutes	10 seconds			Once the detector is turned on, this value sets how long the lights will stay on once movement has ceased.
Lux on level (Switch level on)	9	2, 5 & 7	4, 6 & 9				Lux level setting to prevent the luminaires being switched on if the ambient light level is sufficient (adjustable between 1 and 9). The luminaires will always be switched on at level 9.
Light Level (DD & AD only)	6 (600)			2 (200) 5 (500) 7 (700)	4 (400) 6 (600) 9 (999)		Sets a target light level to be maintained by the lighting system. 9 (999) = disabled.
Lux off level (Switch level off)	9	2, 5 & 7	4, 6 & 9				Lux level setting to switch the luminaires off during occupancy if the ambient light level goes above the setting (adjustable between 1 and 9). Level 9 will always keep the lights on. This setting can be used for "window row switching". <i>Note: the Lux Off Level value must always be greater than the Lux On Level value.</i>
Load Type (DD only)	DALI			2-DALI 7-DSI	2-DALI on		Sets the ballast control protocol to be used by the output channel.
Sensitivity	9	1, 5 & 9	3, 6 & 8				Sensitivity level for detecting movement. 1 = low sensitivity 9 = high sensitivity
Defaults				D			Returns the unit to the default settings.
Burn-in (DD & AD only)	0	0	50	100			Determines how long the output will be at 100% so that lamps 'burn-in'. The 'burn-in' time is not affected by power supply interruptions.
Shift							Use this button to select the settings in red and blue signified by the 'Shift 1' and 'Shift 2' LEDs

Advanced programming

Parameter Name	Default Value	Range / Options	Description	UHS5	UNLCDHS
Detector Parameters					
Walk Test LED	Off	On or Off	When set to On this causes a red LED to flash on the sensor when it detects movement. Use this feature to check for adequate sensitivity levels.	✓	✓
Time Out (Time adjustment)	20 minutes	0-99 minutes	Once the detector is turned on, this value sets how long the lights will stay on once movement has ceased. Select 0 for 10 second delay – use for commissioning only.	✓	✓
Manual Time Out	10 minutes	0-99 minutes	When a manual operation occurs, either via the switch input or the infrared, it invokes the timeout period. Example 1: a detector in presence mode has a detector timeout of 15 minutes and a manual timeout of 3 minutes. When the user leaves the room they press the off button. The sensor will revert to automatic after 3 minutes, and then walking back in the room will turn the lights on. Example 2: using the settings above, the user turns the lights off (say for a presentation) but stays in the room. Every time a movement is detected, the manual timeout period is re-triggered, but when it doesn't pick up for the short timeout period, the sensor will timeout and revert to automatic. This means the lights may turn on inadvertently during the presentation, if the occupants are still for the manual timeout period, so adjust the timing carefully.	✗	✓
Sensitivity On	9	1 (min) to 9 (max)	Sensitivity level for detecting movement when the detector is already on. *UHS5 sets Sensitivity On and Off to the same value.	✓*	✓
Sensitivity Off	9	1 (min) to 9 (max)	Sensitivity level for detecting movement when the detector is off. *UHS5 sets Sensitivity On and Off to the same value.	✓*	✓
Lux time	0	0 (disabled) 1-99 minutes	If the detector measures the lux level and decides that the output needs switching on or off as a consequence, the lux time must elapse first. If at any time during the timed delay the lux change reverses then the process is cancelled.	✗	✓
Power Up State	On	On or Off	Select No for a 30 second delay on start up. If Yes is selected, there will be no delay on start up and the detector will always power up detecting.	✗	✓
Disable Detector	N	Y or N	Disables detection, leaving the relay output permanently off with the dimming output operational. This mode is used when the unit is for maintained illuminance only.	✗	✓
On Delay	0 minutes	0-99 minutes	The On Delay to allows the first channel to switch on after the second channel. A typical application for this would be where a detector is controlling lighting and air conditioning in an area. When the occupant is detected, the lighting will be turned on immediately, whereas the air conditioning may be turned on after 15 minutes. If the area is vacated and the detector times out before the delay, then the air conditioning would never go on. The delay can be set only for channel 1 using the on delay parameter.	✗	✓
Inhibit	4 seconds	1 to 999 seconds	When the detector turns off, a delay is instigated to prevent retriggering. In certain circumstances this delay may not be enough. This parameter allows the delay to be changed.	✗	✓
Verify	N	Y or N	Requires two or more PIR detectors to detect to trigger the lights on.	✗	✓
Factory default	-	-	Restores factory default settings	✓	✓

User Modes					
Raise (DD & AD only)	-	-	Increase light level. Reverts when occupancy cycle complete.	✓	✓
Lower (DD & AD only)	-	-	Decrease light level. Reverts when occupancy cycle complete.	✓	✓
Scene up	-	-	Steps up between 6 pre-defined scenes.	✗	✓
Scene down	-	-	Steps down between 6 pre-defined scenes.	✗	✓
Scene #	-	-	Select the individual scene, between 0 and 6. (1 = min. output; 2 = 10%; 3 = 25%; 4 = 50%; 5 = 75%; 6 = 100%)	✗	✓
Override On	-	-	If the lights are off, sending the IR command will turn them on immediately and revert to automatic operation using the manual timeout period.	✓	✓
Override Off	-	-	If the lights are on, sending the IR command will turn them off immediately. After the manual timeout period (described above), the sensor will revert to automatic.	✓	✓
Cancel	-	-	Cancels the on or off override, returning the detector to normal operation.	✗	✓

Advanced programming

Parameter Name	Default Value	Range / Options	Description	UHS5	UNLCDHS
Channel 1 –Switching Channel(PRM & AD only)					
Lux on level (Switch level on)	9	1 to 9 For a higher resolution a scale of 101-199 is available	Sets a minimum light level below which the PIR sensor is enabled, allowing lights to be turned on by movement. <i>Note: the Lux Level Off value must always be greater than the Lux Level On value.</i>	✓	✓
Lux off level (Switch level off)	9	1 to 9 For a higher resolution a scale of 101-199 is available	Sets a maximum light level above which the PIR sensor is disabled, preventing lights from being turned on by movement.	✓	✓

Channel 2 -Dimming Channel (DD & AD only)					
Lux on level (Switch level on)	9	1 to 9 For a higher resolution a scale of 101-199 is available	Sets a minimum light level below which the PIR sensor is enabled, allowing lights to be turned on by movement. <i>Note: the Lux Level Off value must always be greater than the Lux Level On value.</i>	✓	✓
Lux off level (Switch level off)	9	1 to 9 For a higher resolution a scale of 101-199 is available	Sets a maximum light level above which the PIR sensor is disabled, preventing lights from being turned on by movement.	✓	✓
Light Level (maintained illuminance)	600	1 to 998 (999 disabled)	Sets a target light level to be maintained by the lighting system.	✓	✓
Load Type (DD only)	DALI	DSI DALI DALI On	Sets the ballast control protocol to DSI. Sets the ballast control protocol to DALI. DALI On provides a permanent voltage to DALI ballasts when DALI has not been implemented correctly in the ballast. Maximum number of ballasts is 4 unless the relay is disabled then it is 10.	✓ ✓ ✗	✓ ✓ ✓
Max Value	100%	0 to 100%	Maximum dimming output level.	✗	✓
Min Value	0%	0 to 100%	Minimum dimming output level.	✗	✓
Memorise	N	Yes or No	If this is set to Yes, the last manual lux level set will be memorised and used as the new switch on level.	✗	✓
On value	99	0 to 99	Dimming output level when switched on (0-99).	✗	✓
Off value	0	0 to 99	Dimming output level when switched off (0-99). If a non-zero off value is set, then the output will toggle between this value and completely off depending on the switch level on and off values. For example, if it is light outside, the fittings will be off if there is no occupancy. If it is dark outside, they will adopt the preset off value. This feature is only enabled if 'Min value' is set to 99.	✗	✓
Burn-in	0	0 (disabled) or 1 to 999 hours	Determines how long the output will be at 100% so that lamps 'burn-in'. The 'burn-in' time is not affected by power supply interruptions.	✓	✓
Fade value	10	0 to 99	After occupancy ceases, this dimming output level is loaded for the fade time (adjustable between 0 and 99).	✗	✓
Fade mins	0	0 to 99	This is the time period (adjustable between 0 and 99 minutes) that the luminaire will be held at the fade value before turning off. A value of 0 disables the fade function.	✗	✓
Speed On	40	Measured in 0.1 sec intervals.	Determines the dimming response speed after the setup time has finished.	✗	✓
Speed Set	5	Measured in 0.1 sec intervals.	Determines the dimming response speed during the set up time. Measured in 0.1 sec intervals. If set to 0 will disable dimming for "Set seconds" below, used if fittings are required to warm up before dimming.	✗	✓
Set Seconds	120	1 to 999 seconds	Determines how long the dimming response set-up period lasts on power-up or on setting change. This enables the desired lux level to be achieved rapidly when the lights come on, or during setup.	✗	✓

This page intentionally left blank

Technical data

Dimensions	See diagrams opposite.
Weight	0.15kg
Supply Voltage	230VAC +/- 10%
Frequency	50Hz
Dimming output	Basic insulation only. Although low voltage, this is not an SELV output and should be treated as if mains potential. Use mains rated wiring.
Maximum Switching Load	2 Amps fluorescent and incandescent lighting. 2 Amps compact fluorescent lighting. 2 Amps low energy lighting. 2 Amps low voltage lighting (switch primary of transformer). Switch SON lighting loads via a contactor.
Number of ballasts	EBDHS-MB-DD - up to 10 dimming ballasts EBDHS-MB-AD - up to 4 dimming ballasts.
Power consumption	PRM On 565mW, Off 249mW DD On 577mW, Off 253mW AD On 619mW, Off 290mW
Cable specification	1m 1/1.13 solid core cable 105°C
Temperature	-10°C to 35°C LT30 versions -30°C to 35°C
Humidity	5 to 95% non-condensing
Material	Flame retardant ABS/PC
IP rating	Type Class 2 IP65
Compliance	EMC-2014/30/EU LVD-2014/35/EU
For further compliance information visit www.cpelectronics.co.uk/compliance	

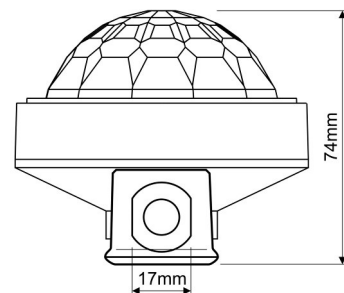
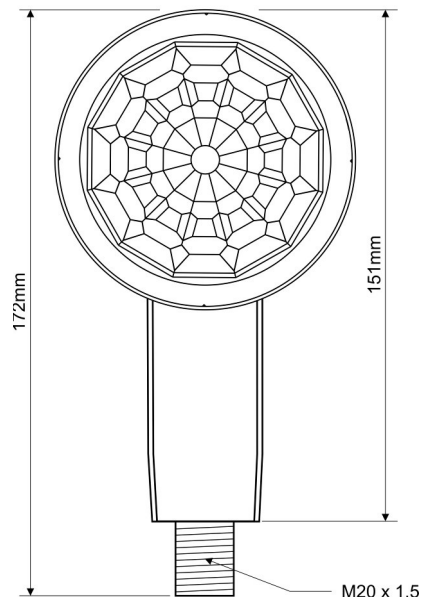

Part numbers

	Part number	Description
Detectors	EBDHS-MB-AD	Luminaire mount high bay PIR detector AD 1-10V
	EBDHS-MB-AD-LT30	Luminaire mount high bay PIR detector AD 1-10V -30°C
	EBDHS-MB-DD	Luminaire mount high bay PIR detector DD DALI/DSI
	EBDHS-MB-DD-LT30	Luminaire mount high bay PIR detector DD DALI/DSI -30°C
	EBDHS-MB-PRM	Luminaire mount high bay PIR detector PRM
	EBDHS-MB-PRM-LT30	Luminaire mount high bay PIR detector PRM -30°C
Accessories	UHS5	Programming IR handset
	UNLCDHS	Universal LCD IR handset

IMPORTANT NOTICE!

This device should be installed by a qualified electrician in accordance with the latest edition of the IEE Wiring Regulations and any applicable Building Regulations.



C.P. Electronics Ltd
Brent Crescent
London
NW10 7XR
United Kingdom
Tel: +44 (0) 333 900 0671
Fax: +44 (0) 333 900 0674
www.cpelectronics.co.uk
enquiry@cpelectronics.co.uk